

Data Sheet



Article number: 50310204

Description: Open pillow block PMN 20 F
FM standard bearing included

Measures

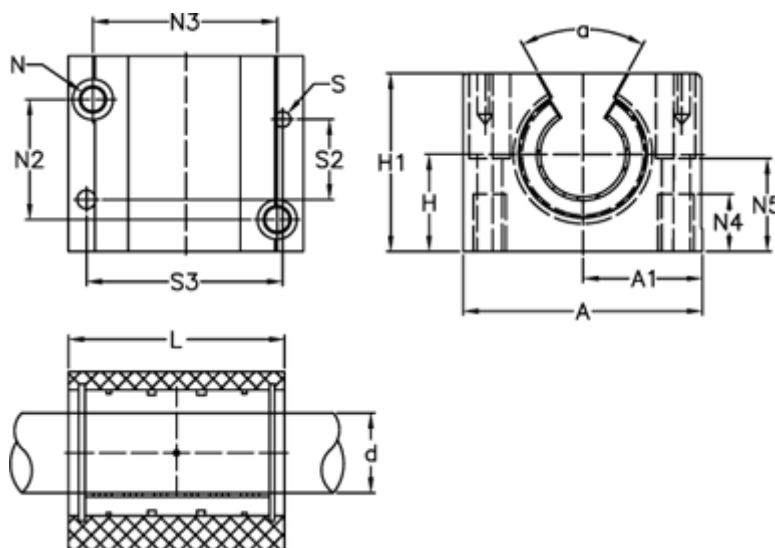

A = 60	N3 = 45.00
a = 60 degrees	N4 = 18
A1 = 30.0	N5 = 24.0
H = 25	S = 5
H1 = 42	S2 = 45
L = 54	S3 = 50
N = M8 x 1,25	Static load (kg) = 945
N2 = 32.00	Weight (kg) = 0.000